



BRANCARD DE TRANSFERT  
À HAUTEUR VARIABLE  
VARIABLE-HEIGHT  
TRANSFER STRETCHER



*Elineo*



Version : 12-2011



# Elineo

Maniable, modulable, sécurisé, facile d'usage et offrant un confort optimal pour vos patients, ELINEO, le nouveau brancard de transfert vous apporte les fonctions essentielles dont vous avez vraiment besoin !

The new ELINEO transfer stretcher fulfils all the essential functions that you really need. It is easy to manoeuvre, safe, easy to use and keeps your patients perfectly comfortable.

## CONFORT / COMFORT

- Ultra maniable : grande facilité de déplacement
- Mise en place des barrières facile et sécurisée
- Barres de poussée disponibles en standard côté tête et côté pied
- Plan de couchage disponible en 4 dimensions et en 2 épaisseurs de matelas (selon version)
- 5<sup>e</sup> roue nouvelle génération pour une meilleure adhérence et efficacité (en option)
- Compatible bed mover\*
- Ergonomic cotsides ensure easy operation
- Easy and secure installation of the side rails
- Push bars at the head and foot ends come as standard
- Various mattresses available to suit customers requirements
  - New-generation fifth castor for better grip and improved performance (option)
    - compatible with most bed movers\*

## ACCESSIBILITÉ ACCESSIBILITY

- Hauteur variable de 57 à 90 cm\*\*
- Commandes d'élévation faciles à manipuler des 2 côtés du brancard
- Grand espace de rangement sous le plan de couchage (en accessoire)
- Variable height from 57 to 90 cm\*
- Easy-to-use elevation controls on both sides of the stretcher
- Large storage facility within the optional oxygen cylinder holder base

\*\* Hauteur sans matelas / Height without mattress



Modèle présenté  
avec options/accessoires  
Product shown  
with options/accessories

## SÉCURITÉ / SAFETY

- Capacité de charge jusqu'à 250 kg
- Proclive / Déclive accessible par commandes bilatérales
- Freinage centralisé aux 4 coins du brancard
- Barrières verticales en inox
- Compatible barrières pédiatriques
- Load capacity of up to 250 kg
- Trendelenburg / Reverse Trendelenburg controls on both sides
  - Centralised brakes at the four corners of the stretcher
    - Stainless steel robust cotsides
    - Compatible with paediatric siderails

## HYGIÈNE / HYGIENE

- Matelas amovible, étanche et antiallergique
- Structure simple sans aspérité et facile à nettoyer
- Carter de protection amovible et facilement démontable sans outils (en accessoire)
- Barrières en acier inoxydable
- Waterproof, anti-allergy mattress
- Simple structure without any protruding parts and easy to clean
- Detachable oxygen bottle holder base that can be removed without any tools (accessory)
  - Stainless Steel cotsides



Position basse  
Low position



Transfert  
Transfer



Proclive  
Reverse trendelenburg



Déclive  
Trendelenburg



Position haute  
High position

## CARACTÉRISTIQUES STANDARD

Hauteur variable de 57 à 90 cm (sans matelas)  
 Procline / Décline accessible par commandes bilatérales  
 Structure acier revêtement époxy polyester gris nuage  
 Plan dur en résine radio transparent compatible C-arm  
 4 roues ø 200 mm avec freinage centralisé,  
 dont 2 directionnelles côté tête (commande aux 4 coins)  
 Dossier relevable par double vérin à gaz  
 4 pare-chocs latéraux + bandes de protection latérale  
 4 supports accessoires  
 Barrières repliables sous le niveau de couchage  
 Poignées de poussée  
 Poids maximum du patient autorisé 250 kg  
**Livré sans matelas**

## STANDARD FEATURES

Variable height from 57 to 90 cm (without mattress)  
 Trendelenburg / Reverse Trendelenburg controls on both sides  
 Polyester epoxy-coated steel structure, cloud grey  
 X-ray translucent resin mattress base, C-arm compatible  
 Four ø 200 mm castors with centralised braking, two steering castors  
 at the head end (controls on all four corners)  
 Dual gas actuator adjustable backrest  
 Four corner bumpers and protective bumpers along the sides  
 Four accessory sockets  
 The Cottsides fold away neatly beside the mattress  
 Push handles  
 Patient weight capacity: 250 kg  
**Various mattress options available to suit specific requirements**

Modèles Models	Longueur Length 190 cm	Longueur Length 205 cm	Largeur Width 66 cm	Largeur Width 75 cm
15245-10M	●		●	
15245-10L	●			●
15745-10M		●	●	
15745-10L		●		●

### Options\*

\* A demander impérativement lors de la commande, montage usine / Plant installed, must be ordered with initial order



5<sup>e</sup> roue directionnelle  
Fifth steering castor



1 jeu de 2 roues  
antistatiques  
One set of two anti-static  
castors



Roulettes « Roll+ »  
« Roll+ » castors



Poignées repliables  
côté tête  
Folding handles  
at the head end



Poignées repliables côté pied  
(incompatible avec le  
porte-dossier patient)  
Folding handles at the foot end  
(not compatible with the patient  
notes holder)

### Accessoires Accessories

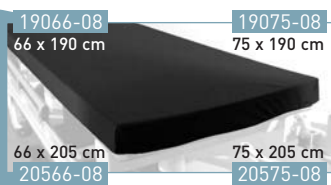

Épaisseur matelas / Mattress thickness  
**8 cm**

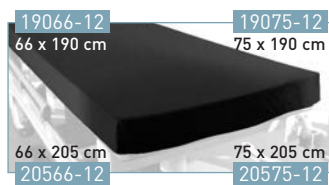

Épaisseur matelas / Mattress thickness  
**12 cm**



Matelas de transfert  
50 mm, housse PVC bleue  
50mm transfer mattress,  
blue PVC cover



Tige porte-sérum  
autobloquant 2 crochets  
Auto-locking 2 hook IV pole

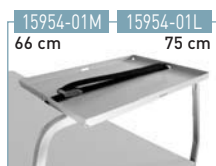

Tablette support  
monitoring  
Monitor support tray



Porte-rouleau réglable  
Adjustable paper-roll holder  
(350-750 mm)

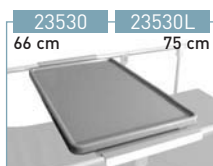

Tablette repas  
Dining tray



Paire de protections  
pédiatriques pour barrières  
Pair of padded cotside  
bumpers



Porte-dossier patient  
incompatible avec les  
poignées repliables côté pied  
Réf. 15956-01  
Patient notes holder  
incompatible with the folding  
handles at the foot end  
Ref. 15956-01



Cartier amovible  
porte-bouteille oxygène  
(dim. D, E, F)  
Removable oxygen bottle  
holder base (dim. D, E, F)

Couleurs de matelas  
non-feu M1 - Antibactérien  
Mattress colors  
of M1 fire retardant upholstery  
antibacterial

Matelas soudé  
Welded mattress

NOIR / BLACK

MARINE / MARINE



15245-10M  
+ 19066-08

Poids net  
Net weight  
99 kg\*

Poids brut  
Gross weight  
147 kg\*

Volume  
1,45 m<sup>3</sup>

\* Poids « nu » :  
sans matelas,  
sans carter, sans tige  
porte-sérum.  
Version : 66 x 190 cm

\* Weight when bare:  
without the mattress,  
housing and IV pole.  
Version: 66 x 190 cm

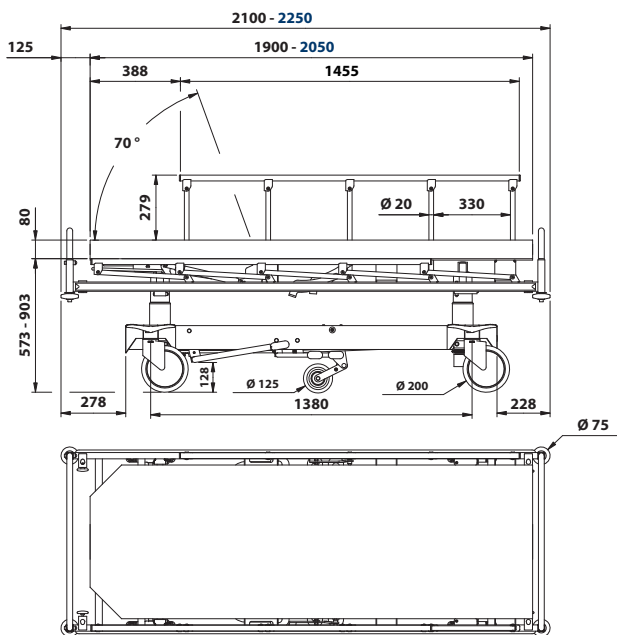

Largeur 66 cm  
Width 66 cm

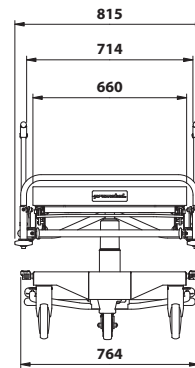

Largeur 75 cm  
Width 75 cm

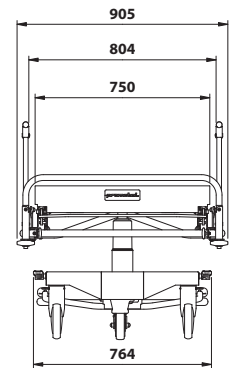

Proctive / décline : 14°  
Trendelenburg / reverse trendelenburg: 14°

G007/FE-51/11

Midmark Europe SAS  
22, rue de Saint-Denis - 53500 Ernée  
www.promotal.com

